

3x3 Mesh Router

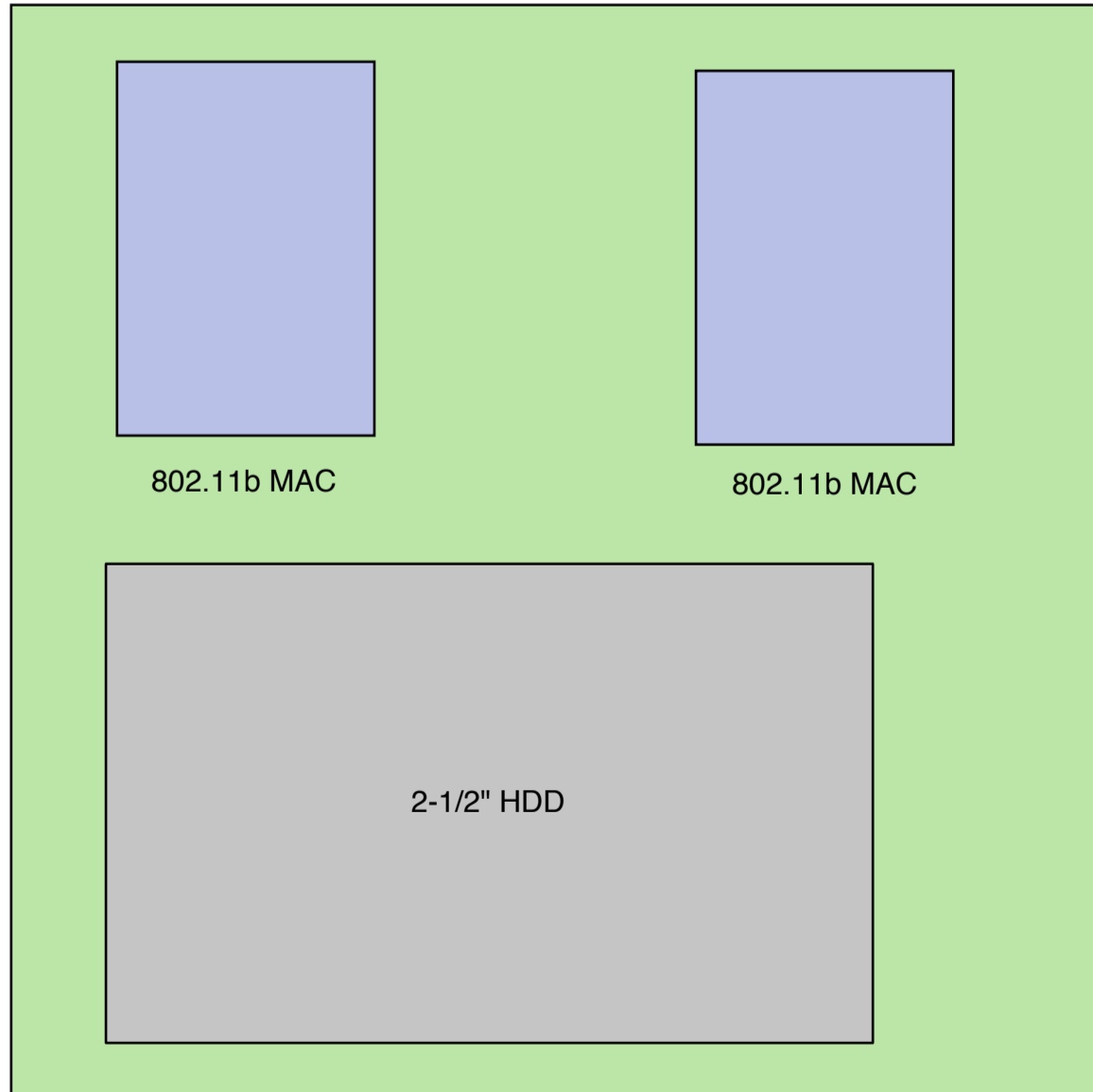
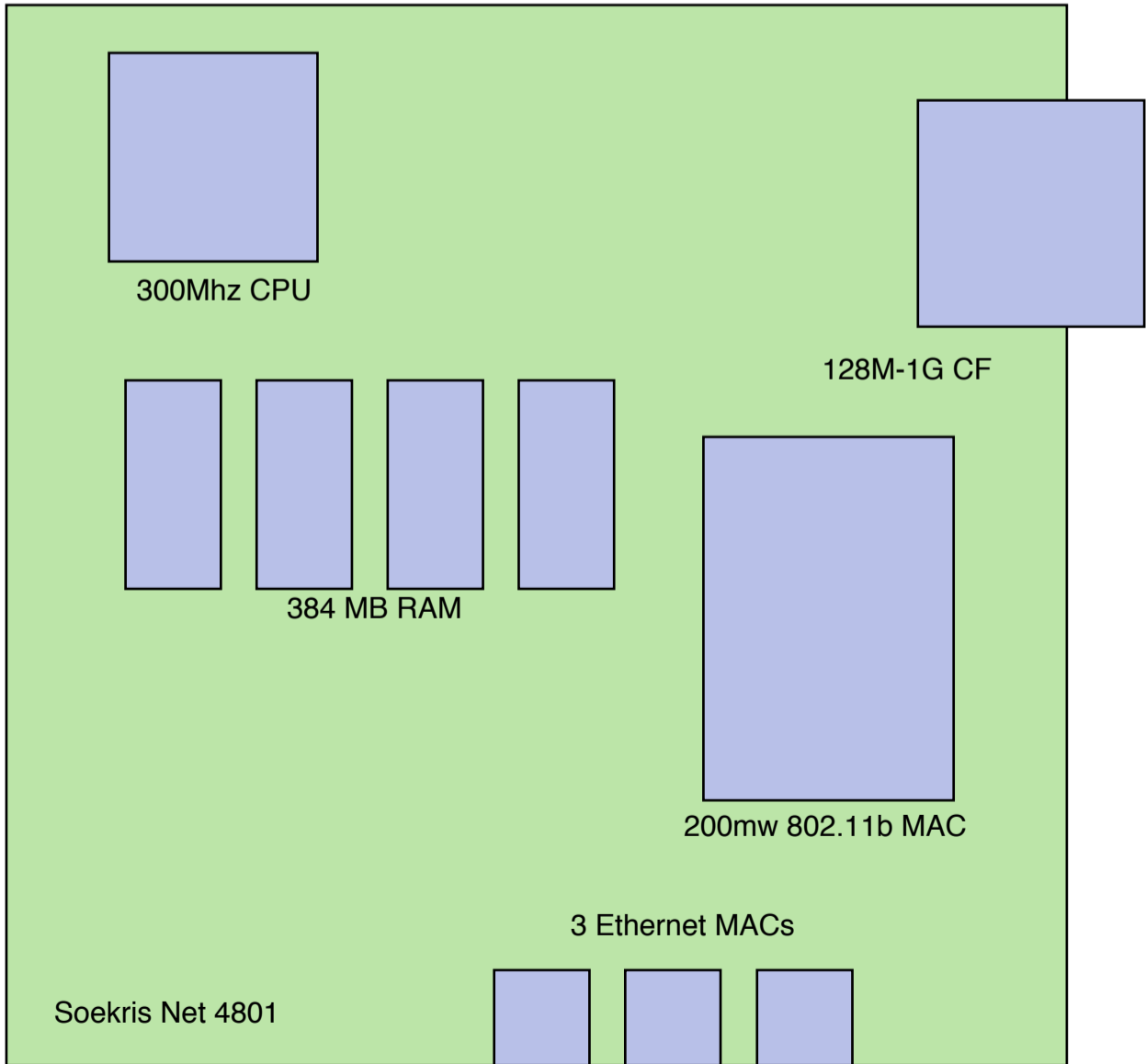
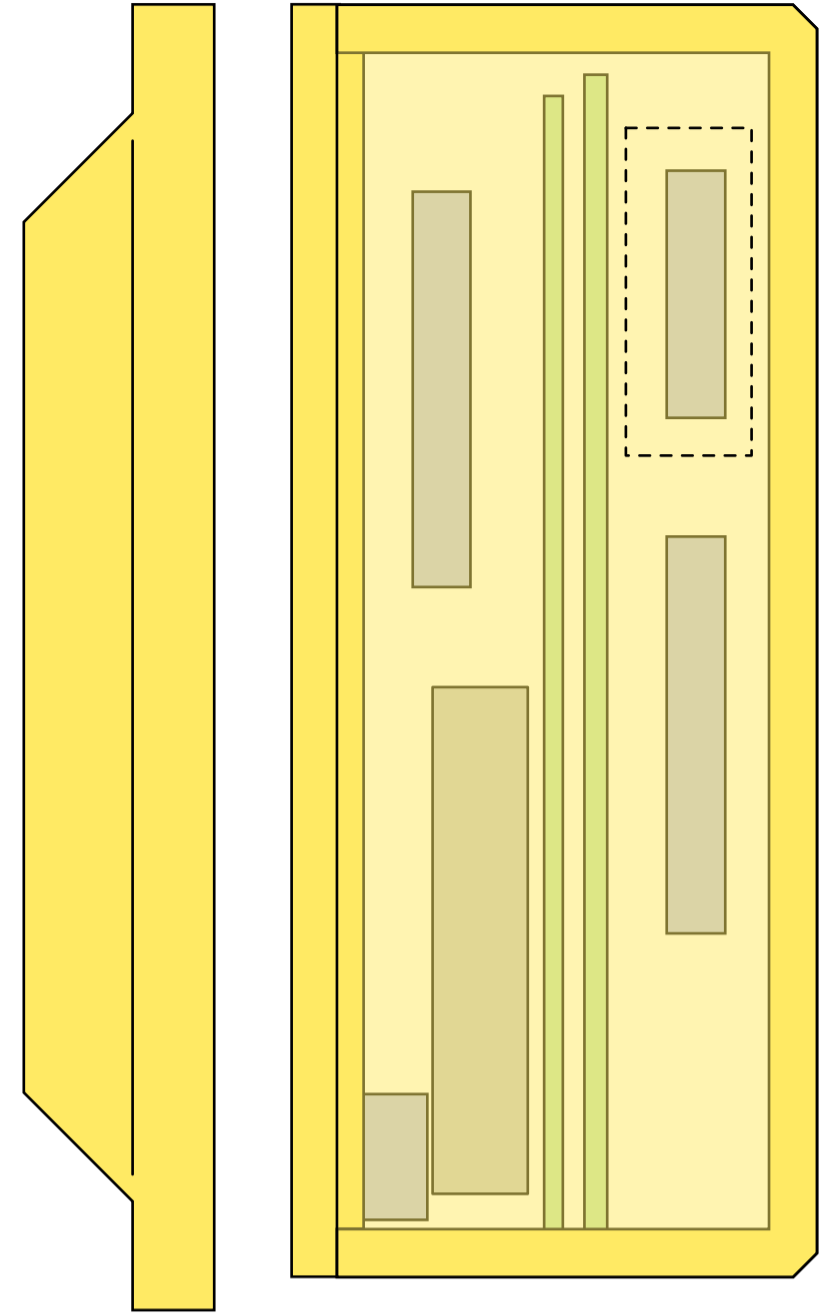
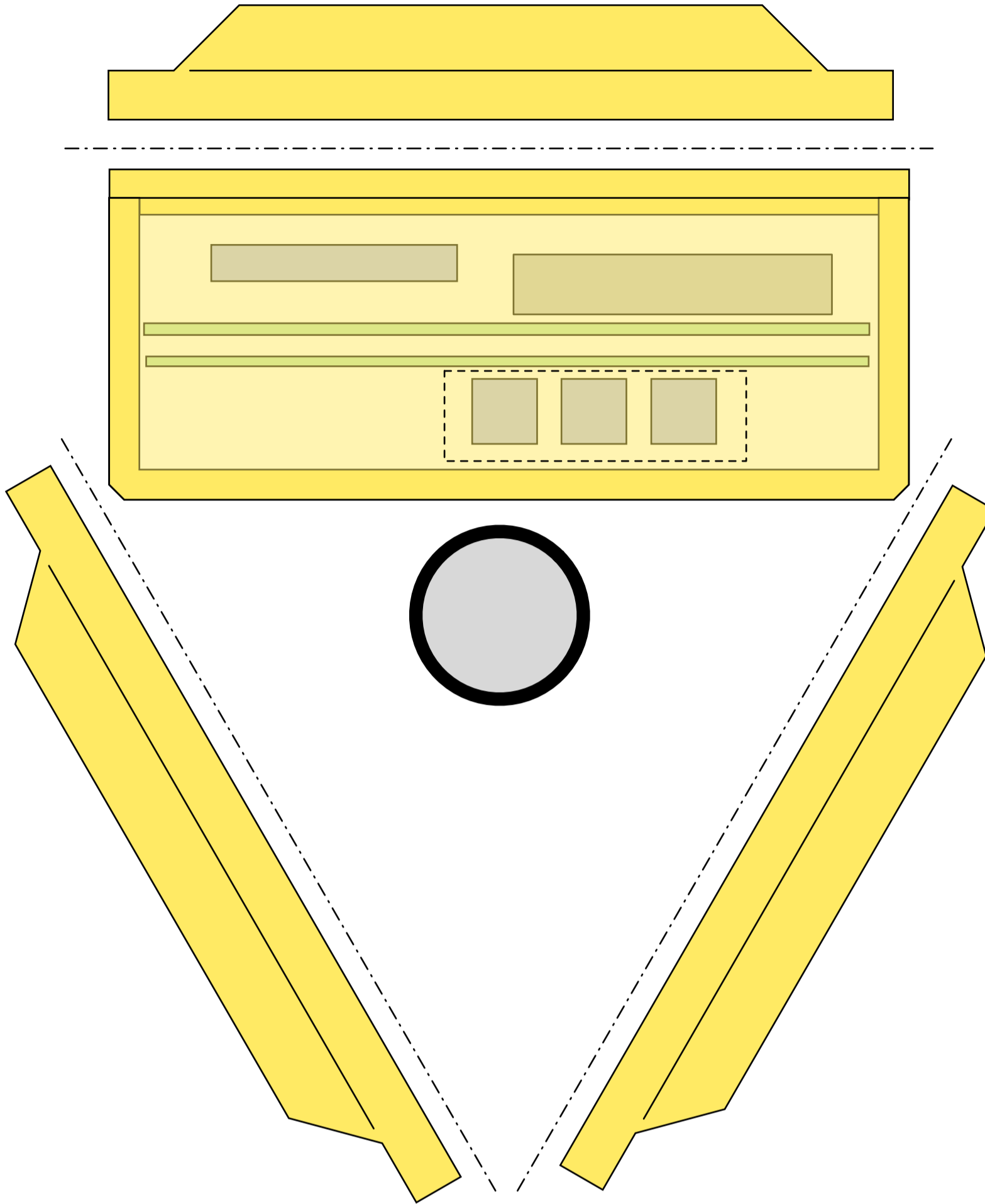
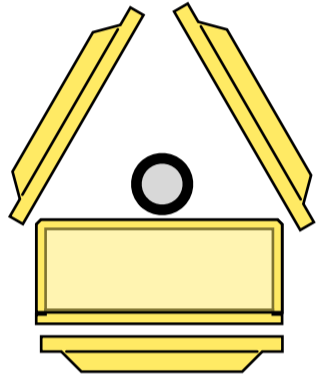
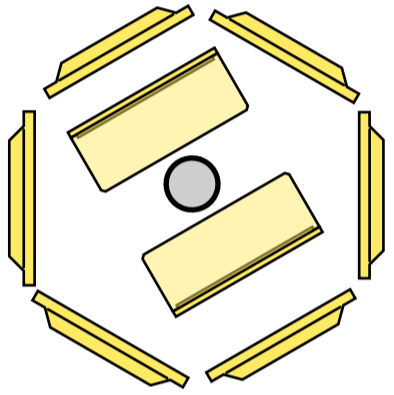
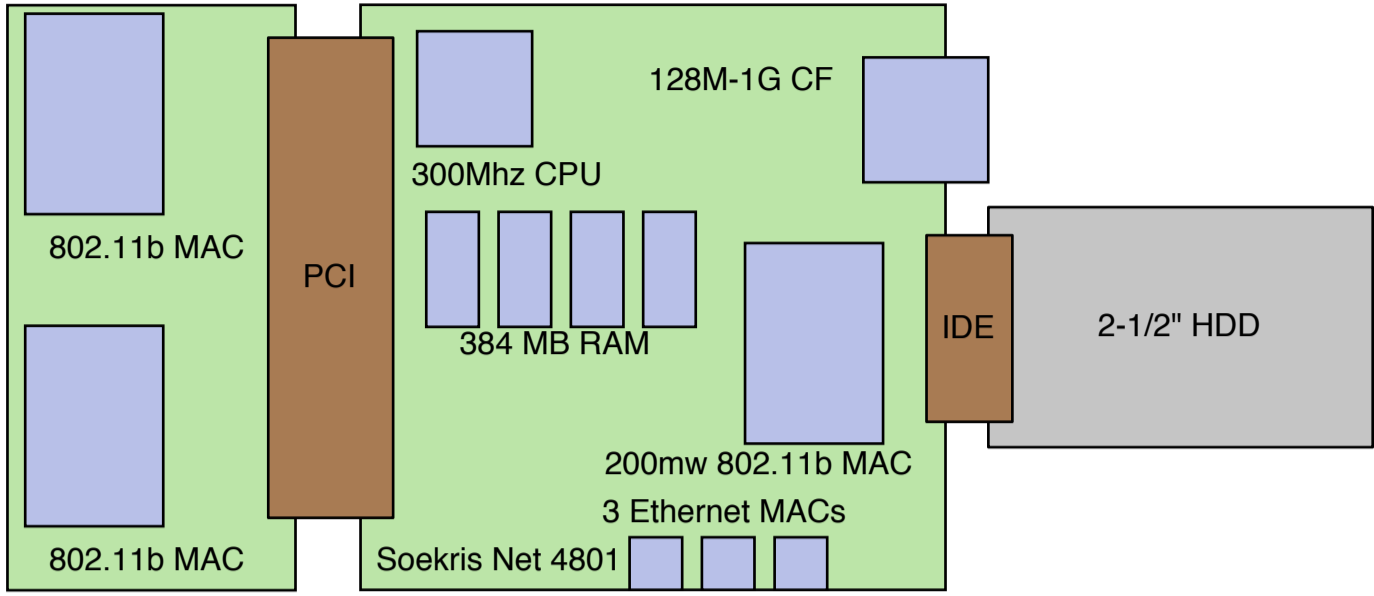

Production Costs Estimate

Component	Cost
* 3x3 Mesh Router	\$ 953.00
* Components	\$ 770.00
* Soekris Net 4801 SBC 384MB RAM, PoE	\$ 150.00
* Dual MiniPCI Daughterboard	\$ 30.00
* 200mw 802.11g MiniPCI MAC	\$ 100.00
* 200mw 802.11g MiniPCI MAC	\$ 100.00
* 12dbi Antenna with 120° Spread	\$ 50.00
* 12dbi Antenna with 120° Spread	\$ 50.00
* 12dbi Antenna with 120° Spread	\$ 50.00
* Weatherproof Enclosure	\$ 40.00
* 128MB-1GB CF	\$ 25.00
* PoE Injector	\$ 25.00
* Connectors	\$ 50.00
* Assembly	\$ 100.00
* 60 Minutes Skilled Labour	\$ 100.00
* Testing	\$ 50.00
* 24 Hour Burn-In Power & Labour	\$ 50.00
* Shipping	\$ 33.00
* Packing	\$ 18.00
* Materials	\$ 10.50
* 15 Minutes Unskilled Labour	\$ 7.50
* Postage	\$ 15.00